The logo for Sunquest Solar Heating System is centered at the top of the page. It features the word "SUNQUEST" in a large, bold, sans-serif font with a trademark symbol (TM) to its upper right. Below "SUNQUEST" is the word "SOLAR" in a similar font, and below that is "HEATING SYSTEM" in a slightly smaller font. The text is set against a dark, circular background that resembles a sun or a solar panel, with a gradient from dark to light.

**SUNQUEST™
SOLAR
HEATING SYSTEM**

Model # SQ-1220

**INSTALLATION & OPERATION
MANUAL**

Read all the instructions before installing your solar heating system.

How does a solar heating system work?

1. Connect your existing pool pump to the solar panel. Your pool pump sends cold water to the solar panel.
2. The sun heats the water in the solar panel.
3. Warm water is then returned to your swimming pool.

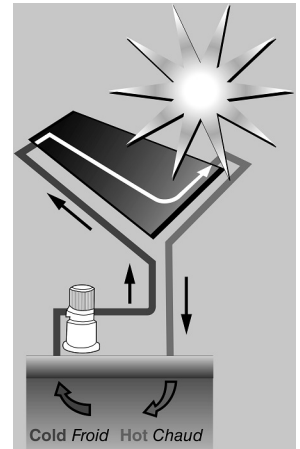

How well does solar heating work?

A solar heating system if sized and installed properly will raise your pool water temperature up to 10° F / 6° C and extend your swimming season. In order to maximize the heat, the solar panel must be exposed to sunlight as long as possible. On rainy days and at night the solar panel must be turned off so your pool water doesn't cool. You can purchase an optional diverter kit to accomplish this. On cloudy days, the solar panel won't work as well. It is recommended to use a solar blanket or a Liquid Solar Blanket. This will help maintain the heat generated by the solar panel in your pool.

Is a special pump required?

No, you can use your existing pool pump as long as it is in good working condition and 3/4HP (minimum). If the panel is placed more than 9 meters (30 ft) away from your pool or one story up, then your pump may need to be 1HP or more.

Where can the solar panel be placed?

The solar panel can be placed on the ground. Avoid placing in high traffic areas, as it is not recommended to walk on the solar panel. The solar panel can also be mounted on a rack or a roof. When mounted, the panel should preferably be facing south and be inclined at a 30° to 45° degree angle. Don't face the panel North, because it will not heat. A mounting kit (**part#SQ-RMK5**) is required for placing the solar panel on a rack or roof.

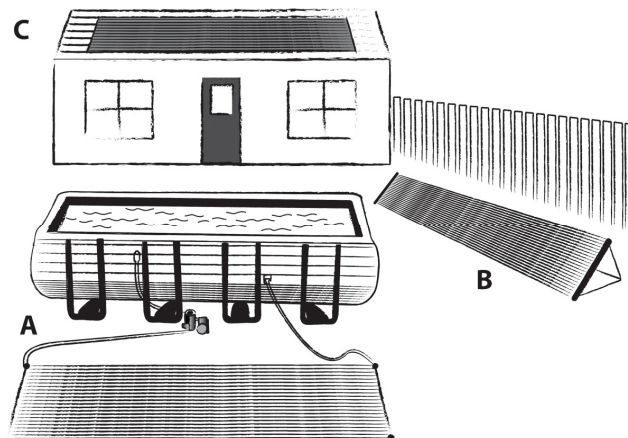

Minimum recommended number of panels

Above-Ground Round Pool	Above-Ground Oval Pool	No. of Panels	In-Ground Pool	No. of Panels
Up to 12'	-	1	Up to 15' x 30'	4-5
15'	12' x 20'	2	Up to 16' x 36'	6-7
18'	12' x 24'	3	Up to 20' x 40'	8-10
21'	12' x 28'	4		
24'	16' x 25'	5		
27'	16' x 32' to 18' x 34'	6-7		

This is the minimum recommended number of panels for a typical installation on a south facing roof with 4-6 month swimming season. Sizing a solar swimming pool heating system involves many factors : pool size, length of swimming season, average regional temperatures, desired pool temperature and solar panel orientation. Use of a pool cover like LiquidHeat will help keep more heat in your pool.

Box Contents:

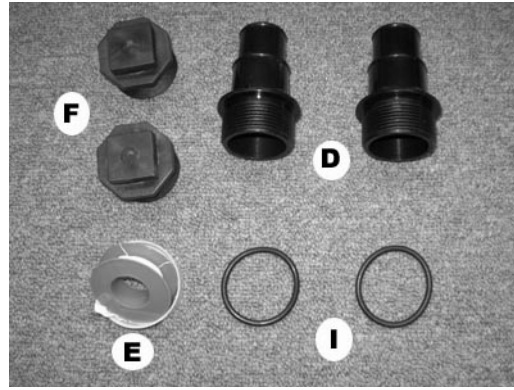

Qty	Part #	Description
1	SK-1220	SunQuest solar panel 2ft x 20ft

Qty	Part #	Description
2	SK-FTG-D	Threaded combination hose adapter
2	SK-FTG-I	"O" rings
2	SK-FTG-F	Threaded cap
1	SK-FTG-E	Roll of Teflon tape

Optional parts

Roof Mounting Kit (SQ-RMK5)

1 - SQ-RMK5 per SQ-1220 system are required for Roof or Rack installation

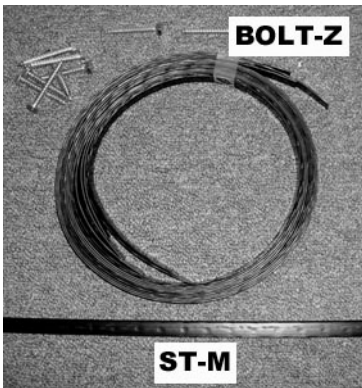

Qty	Part #	Description
5	SK-RMK-ST-M	Coated metal strap
15	BOLT-Z	Lag bolt 2"

High Wind Roof Mounting Kit (SQ-HWK)

For high wind areas, to be used in addition to the roof mounting kit (SQ-RMK5). 1 - SQ-HWK per SQ-1220 system is required plus one extra.

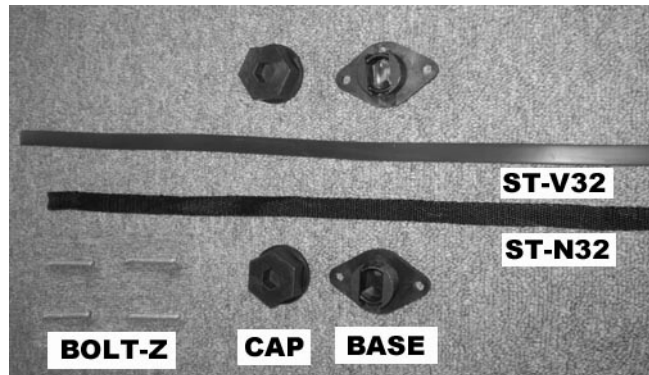

Qty	Part #	Description
2	SK-RMK-BASE	Mounting base
2	SK-RMK-CAP	Mounting Cap
1	SK-RMK-ST-N32	Nylon strap 32"
1	SK-RMK-ST-V32	Vinyl strap 32"
4	BOLT-Z	Lag bolt 2"

Optional parts (cont.)

Add-on Kit (SQ-ADDON)

1 SQ-ADDON required per SQ-1220 system added

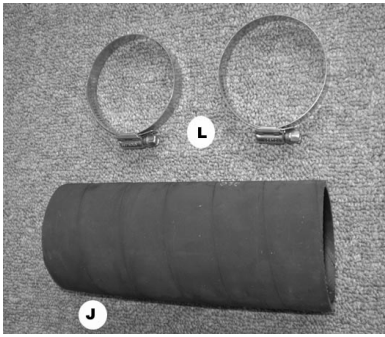

Qty	Part #	Description
1	SK-FTG-J	Rubber hose 7.5"
2	SK-FTG-L	Metal collar (Hose clamp)

Diverter Kit (SQ-DK)

Used to turn your system ON & OFF

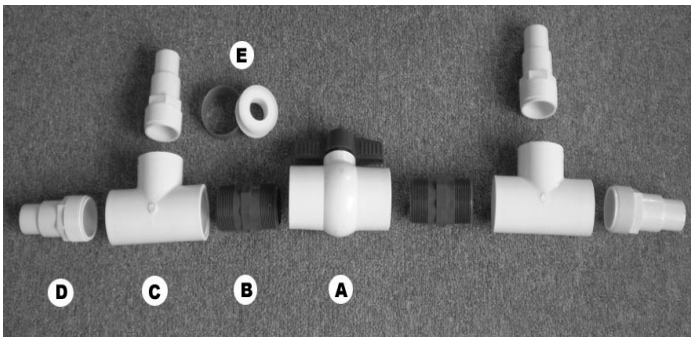

Qty	Part #	Description
1	SK-FTG-A	Threaded 2 way valve
2	SK-FTG-B	Threaded nipple
2	SK-FTG-C	Threaded tee
4	SK-FTG-D	Threaded combination hose adapter
1	SK-FTG-E	Roll of Teflon tape

Vaccum relief Kit (SQ-VRK)

Facilitates drainage for winterizing roof mounted systems

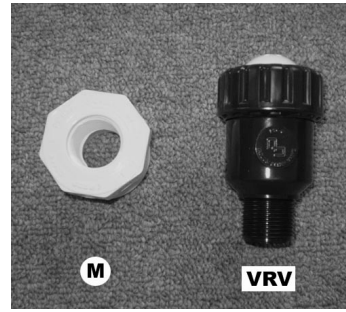

Qty	Part #	Description
1	SK-VRV	Vacuum Relief Valve
1	SK-FTG-M	Reducer Adapter 1.5" to 0.75"

System Kit (SQ-SK)

Everything needed to connect 3 SQ-1220 systems

Includes add-on kits, vacuum relief kit, high wind kits & diverter kit

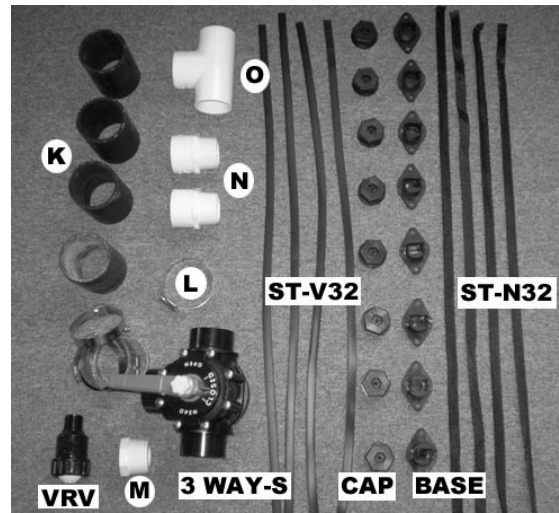

Qty	Part #	Description
4	SK-FTG-K	Rubber hose 3.75"
8	SK-FTG-L	Metal collar (Hose clamp)
1	SK-VRV	Vacuum Relief Valve
1	SK-FTG-M	Reducer Adapter 1.5" to 0.75"
2	SK-FTG-N	PVC Adapter
4	SK-RMK-ST-N32	Nylon strap 32"
4	SK-RMK-ST-V32	Vinyl strap 32"
8	SK-RMK-BASE	Mounting base
8	SK-RMK-CAP	Mounting Cap
1	VALVE-3WAY-S	3 Way Diverter Valve
1	SK-FTG-O	PVC Tee

INSTALLATION

Additional parts required

- Flexible pool hose or rigid PVC pipe. Length dependent on distance from pool pump to solar panels.
- Metal collars (Hose clamps) - Quantity dependant on installation.
- For rack or roof placement a mounting kit (**part # SQ-RMK5**) is required

Tools required

- Flat head screwdriver.
- For rack or roof placement: a utility knife, a power drill and silicone sealant.

PANEL ASSEMBLY

1. Choose placement for your solar panel(s). Make sure that it will be in the sun for most of the day. The area should be clear of sharp objects.
2. Take the panel out of the box, remove the strap from panel and let the panel sit in the sun for approximately 30 minutes so it will become flexible.
3. a) **Installation: one system on ground.**

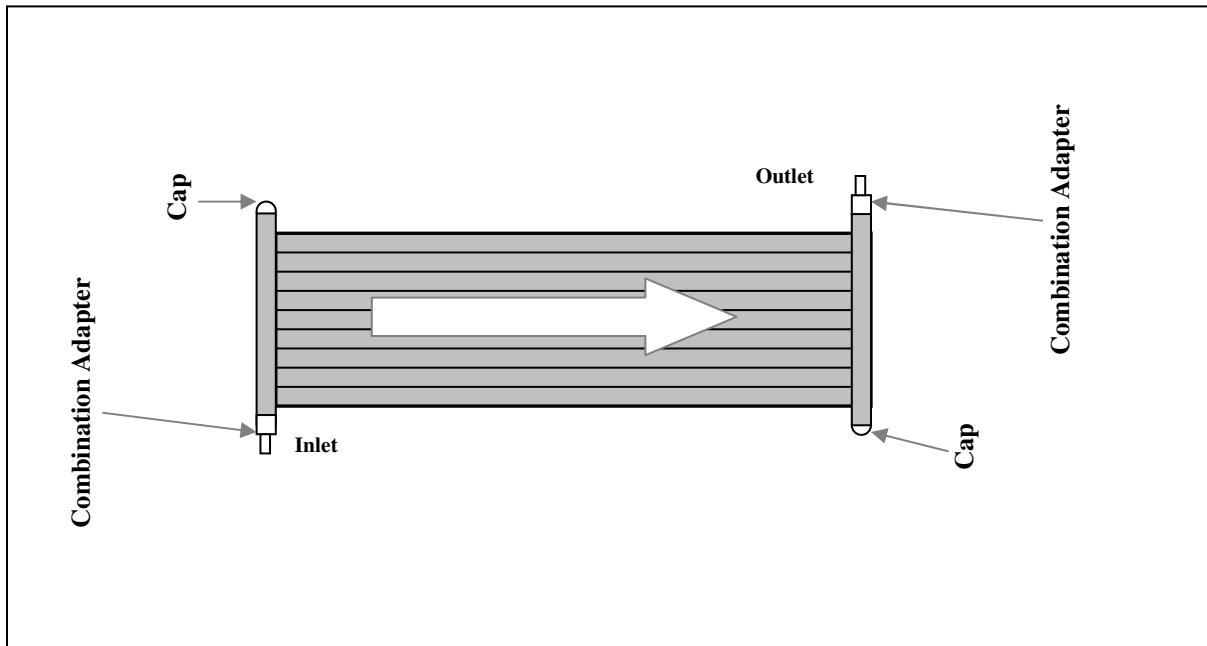

Diagram Step 3a

- Apply Teflon tape to threads of 2 caps (**SK-FTG-F**) See Fig 3a-1
- Thread 2 caps into the panels as per Diagram Step 3a. Do not over tighten. See Fig 3a-2
- Put "O" rings (**SK-FTG-I**) on both combination adapters (**SK-FTG-D**) See Fig 3a-3
- Thread both combination adapters into the panels as per Diagram Step 3a. Do not over tighten. See Fig 3a-4



- 3 b) **Installation: one system on rack or roof. (Horizontal only)**
1 - Mounting kit (part # SQ-RMK5) is required

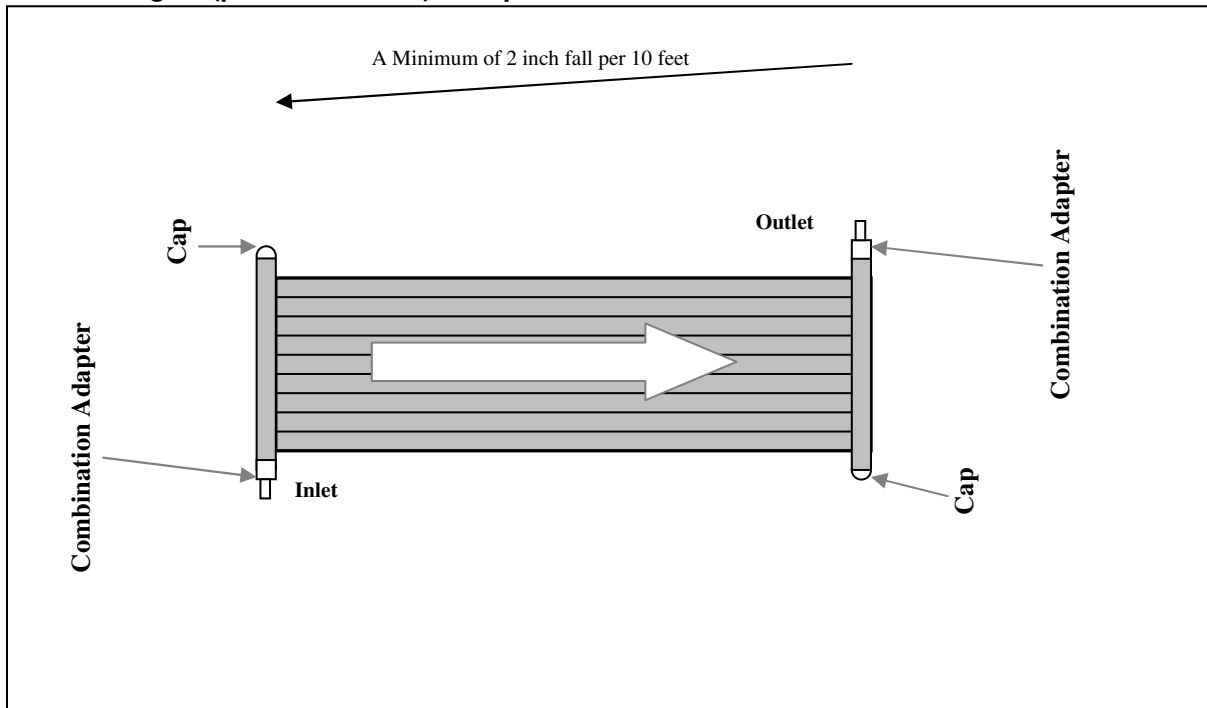

Diagram Step 3b

- Apply Teflon on two of the caps (**SK-FTG-F**). See Fig 3a-1.
- Thread the 2 caps into the panels as per Diagram Step 3b. Do not over tighten. See Fig 3a-2
- Put "O" rings (**SK-FTG-I**) on both combination adapters (**SK-FTG-D**). See Fig 3a-3
- Thread both combination adapters into the panels as per Diagram Step 3b. Do not over tighten. See Fig 3a-4
- Install mounting kits as per instructions included with them. **Panels must be installed with a slight slope (minimum 2 inch per 10 feet) toward the inlet.** This will allow the panel to drain properly.

Note: The inlet must always be at the lower end of the panel and the outlet at the higher end of the panel.

3. c) **Installation: multiple systems on ground.**
 1 Add-on kit (part # SQ-ADDON) is required per extra system.

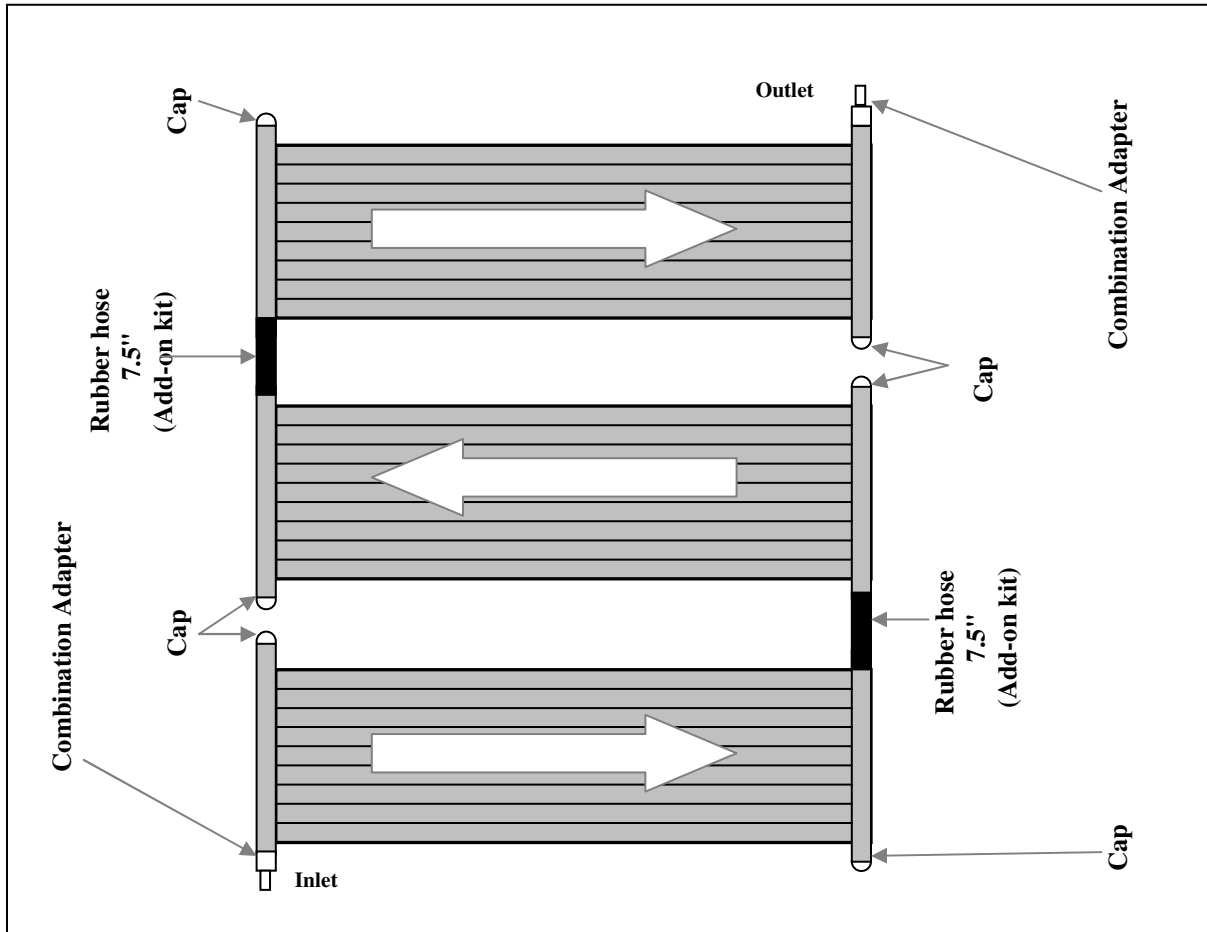

Diagram Step 3c

- Apply Teflon tape to threads of all the caps (**SK-FTG-F**) See Fig 3a-1
- Thread all the caps into the panels as per Diagram Step 3c. Do not over tighten. See Fig 3a-2
- Put "O" rings (**SK-FTG-I**) on two combination adapters (**SK-FTG-D**) See Fig 3a-3. You will only need 2 combination adapters for this type of installation.
- Thread both combination adapters into the panels as per diagram Step 3c. Do not over tighten. See Fig 3a-4

Note: For an even # of system the inlet and outlet will be on the same side
For an odd # of systems the inlet and outlet will be diagonally opposed

- Push the rubber hose (**SK-FTG-J**) from the Add-on kit (**SQ-ADDON**) over the panel header as per diagram Step 3c. Slide a metal collar (**SK-FTG-L**) onto the rubber hose. Place a metal collar $\frac{1}{4}$ " from edge and tighten collar with screwdriver. See Fig 3c-1. Repeat for each system.
- Slide another metal collar onto the rubber hose. Connect the 2 panels together by pushing the rubber hose over the second panel header. Tighten metal collar to secure assembly. See Fig 3c-2. Repeat for each system.



Note: A maximum of 6 2ft panels (6 systems) may be plumbed in series

- 3 d) **Installation: multiple systems on rack or roof. (Horizontal only)**
1 Mounting kit (part # SQ-RMK5) is required per system.
1 System kit (part # SQ-SK) is required.

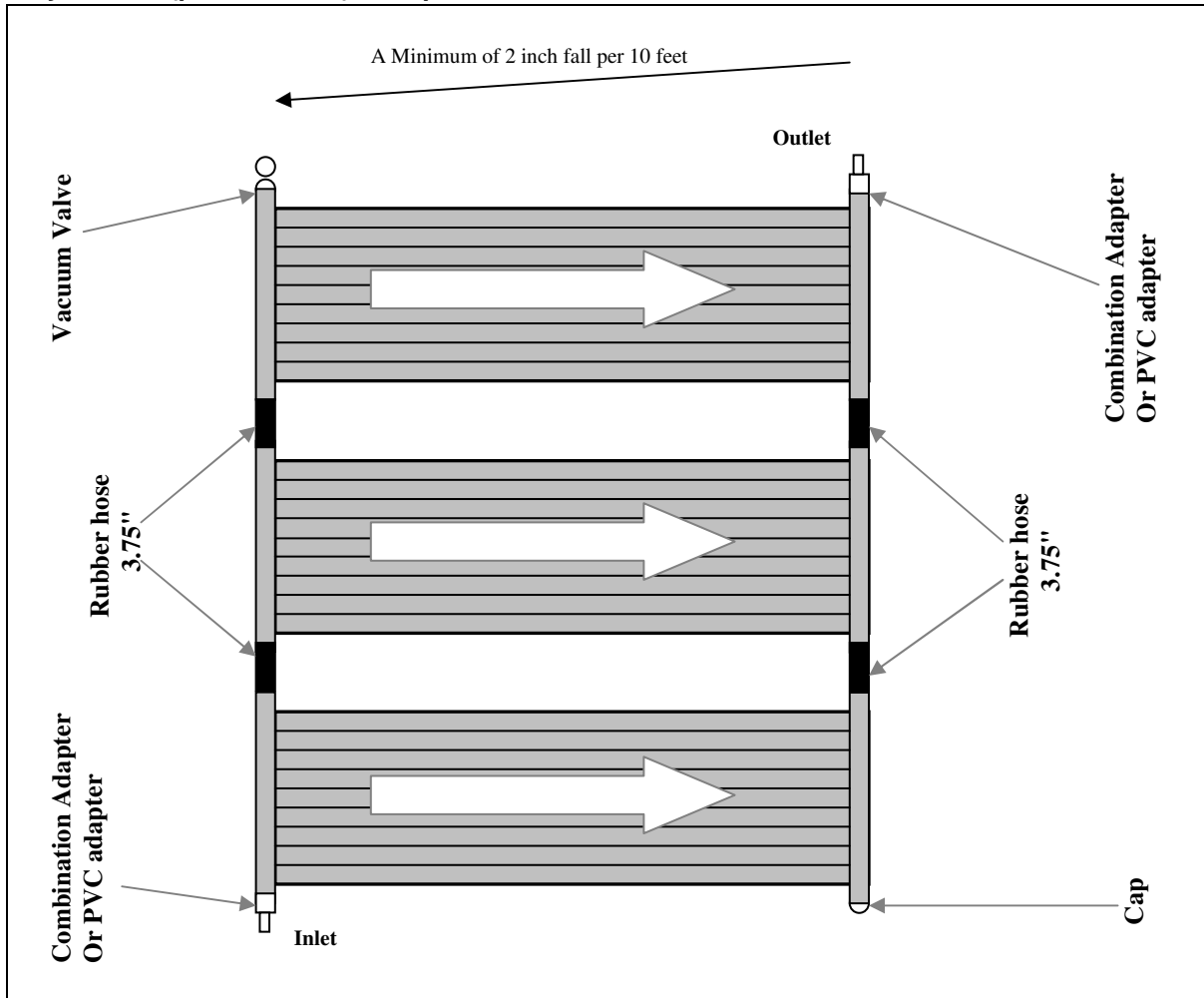

Diagram Step 3d

- Apply Teflon on one of the caps (**SK-FTG-F**). See Fig 3a-1. You only need 1 cap for this type of installation.
- Thread the cap into the panels as per Diagram Step 3d. Do not over tighten. See Fig 3a-2
- If you are using flexible piping to connect panels to your pump then Put "O" rings (**SK-FTG-I**) on both combination adapters (**SK-FTG-D**) See Fig 3a-3. Thread both combination adapters into the panels as per Diagram Step 3d. Do not over tighten. See Fig 3a-4

OR

If you are using rigid piping to connect panels to your pump then apply Teflon on both PVC adapters (**SK-FTG-N**). See Fig 3d-1. Thread both adapters into the panels as per Diagram Step 3d. Do not over tighten. See Fig 3d-2.

- Apply Teflon on reducer adapter (**SK-FTG-M**) included in the system kit (**SQ-SK**) sold separately. Thread reducer adapter into the panel as per diagram Step 3d. Do not over tighten. See Fig 3d-3..
- Apply Teflon on vacuum relief valve (**SK-VRV**). Thread vacuum relief valve into the reducer adapter. Do not over tighten. See Fig 3d-3.



Note: The vacuum valve assembly must be installed at the top of the panels as per diagram Step 3d.

3 d) Cont.

- Push the rubber hose from the system kit (**SK-FTG-K**) over the panel header as per diagram Step 3d. Slide a metal collar (**SK-FTG-L**) onto the rubber hose. Place metal collar $\frac{1}{4}$ " from edge and tighten collar with screwdriver. See Fig 3c-1. Repeat for other end of panel.
- Slide another metal collar onto the rubber hose. Connect the 2 panels together by pushing the rubber hose over the second panel header. Tighten metal collar to secure assembly. See Fig 3c-2. Repeat for other end of panel.
- Repeat previous 2 steps for each subsequent system
- Install mounting kits as per instructions included with them. **Panels must be installed with a slight slope (minimum 2 inch per 10 feet) toward the inlet.** This will allow the panel to drain properly.

Note: The inlet must always be at the lower end of the panel and the outlet at the higher end of the panel.

Note: A maximum of 12 2ft panels (12 systems) may be plumbed in parallel

- For high wind areas you can install the Nylon straps and Vinyl straps from System Kit. Mark a spot 6" to the right of the outlet. Mark spots 6" to the right of every second rubber hose that are on the same side as the outlet. Mark a spot 6" to the right of the cap. See Fig 3d-4. Place mounting base (**SK-RMK-BASE**) on these spots. Drill pilot holes, apply silicone roof sealant and screw mounting base into roof. See Fig 3d-5. Wrap a Nylon strap (**SK-RMK-ST-N32**) around the panel header (see Fig 3d-7) or around rubber hose (see Fig 3d-6). Lay both ends of strap in the mounting base and pull tight. See Fig 3d-8. Screw on mounting cap. (**SK-RMK-CAP**). See Fig 3d-9. Repeat process on the inlet side of the panels but using the Vinyl straps (**SK-RMK-ST-V32**) instead.

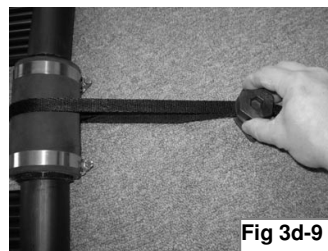
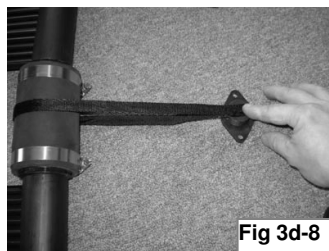
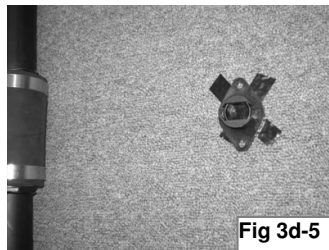
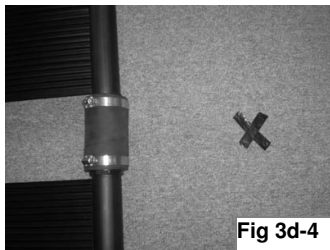

CONNECTING TO POOL

System with no diverter

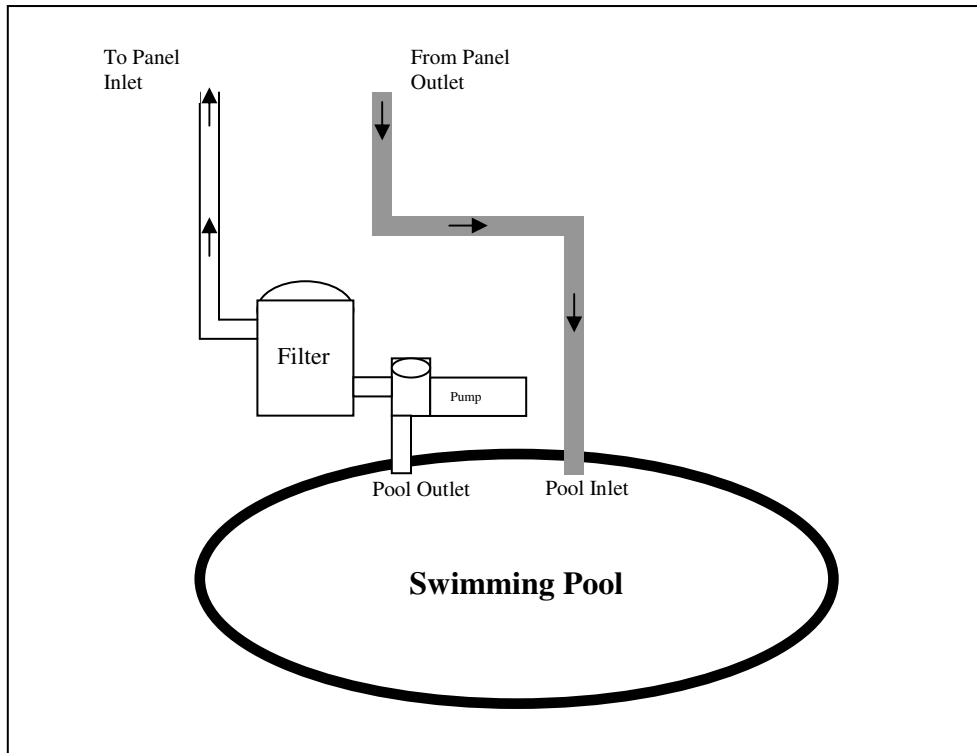

Diagram C-1

1. Turn off your pool pump. Block the inlet and outlet of your pool so that the water won't empty when you are connecting your panel(s).
2. Remove the hose from the pool inlet (hose between the filter and the pool) and connect the hose to the panel inlet. If hose is too short, you need to purchase a new one. Make sure you purchase the appropriate size that is compatible with your existing pool equipment. For 1¹/₄" hose, it will only slide over the small end of the combination adapter. See Fig C1-1. For 1¹/₂" hose, it will slide all the way to flange of combination adapter. See Fig C1-2. Place metal collar ¹/₄" from edge and tighten collar with screwdriver. See Diagram C-1.
3. Connect another hose (not supplied) from the panel outlet to the pool inlet. See Diagram C-1.
4. Make sure that your hoses are all connected the correct way and that all the collars have been tightened. Unblock the inlet and outlet of your pool.
5. Turn on your pool pump. Check for any leaks. If any of the threaded fittings leak, remove the fitting and apply more Teflon. If any of the hoses leak at the connection, loosen the collar and push the hose over the fitting and re-tighten the metal collar. You will see air bubbles coming from the pool inlet. This is normal and will stop once the air inside the panels has been purged.



Note : Without a diverter, your solar heating system is always ON. At night, your solar panels will cool your swimming pool. We recommend you close your pump at night to avoid this or purchase a diverter kit (SQ-DK)

System with diverter (part # SQ-DK)

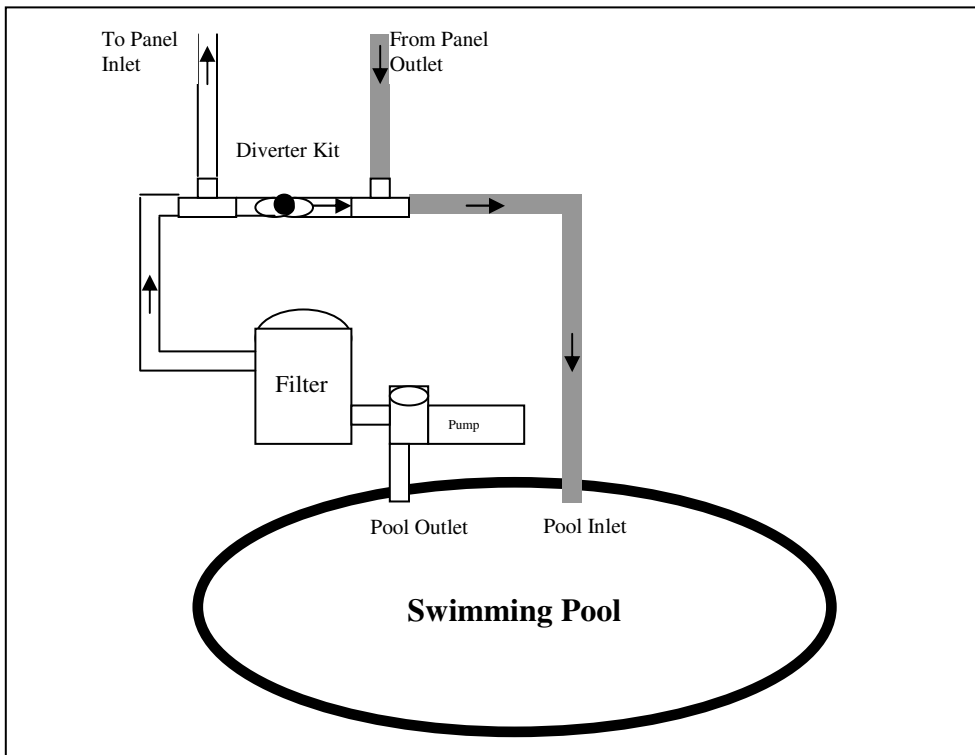

Diagram C-2

1. Turn off your pool pump. Block the inlet and outlet of your pool so that the water won't empty when you are connecting your panel(s).
2. Remove the hose from the pool inlet (hose between the filter and the pool) Connect the hose to one side of the diverter kit previously assembled as per instructions included with diverter kit. For 1¹/₄" hose, it will only slide over the small end of the combination adapter. See Fig C1-1. For 1¹/₂" hose, it will slide all the way to flange of combination adapter. See Fig C1-2. Place metal collar ¹/₄" from edge and tighten collar with screwdriver. See Diagram C-2.
3. Take a hose (not supplied) long enough to reach the panel and connect one end to the diverter kit (same side of the two-way valve as in step 2) Place metal collar and tighten. Connect other end of the hose to the panel inlet. Place metal collar and tighten. See Diagram C-2.
4. Take another hose (not supplied) and connect it to the panel outlet. Place metal collar and tighten. Connect other end of the hose to the diverter kit. Place metal collar and tighten. See Diagram C-2.
5. Take the last hose (not supplied) and connect it to the last open end of the diverter kit. Place metal collar and tighten. Connect the other end of the hose to your pool inlet. Place metal collar and tighten. See diagram C-2.
6. Make sure the valve on the diverter is on the open position.

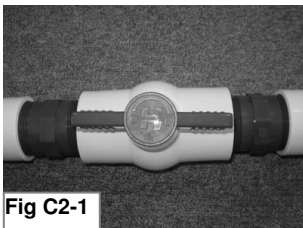

Fig C2-1
Valve in the **open** position
Solar heating is **OFF** (not heating)



Fig C2-2
Valve in the **closed** position
Solar heating is **ON** (heating)

7. Make sure that your hoses are all connected the correct way and that all the collars have been tightened. Unblock the inlet and outlet of your pool.
8. Turn on your pool pump. Check for any leaks. If any of the threaded fittings leak, remove the fitting and apply more Teflon. If any of the hoses leak at the connection, loosen the collar and push the hose over the fitting and re-tighten the metal collar. You will see air bubbles coming from the pool inlet. This is normal, the air in the hoses is being purged.
9. Turn your solar heating system on by turning the two-way valve in the diverter to the closed position. See Fig C2-2. Once again you will see air bubbles coming from your pool. The system is now purging the air that is in the solar panel(s).

System with system kit (part # SQ-SK)

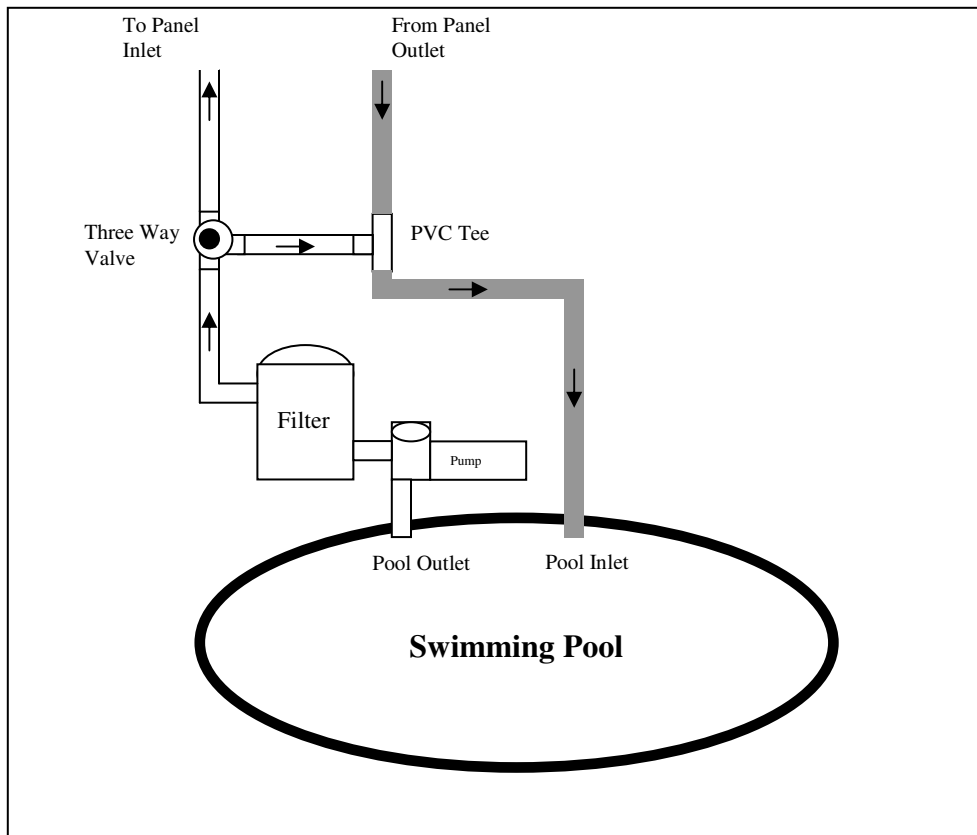

Diagram C-3

1. Turn off your pool pump. Block the inlet and outlet of your pool so that the water won't empty when you are connecting your panel(s).
2. Install Three Way diverter Valve (**VALVE-3WAY-S**) and the PVC Tee (**SK-FTG-O**) on pool return line after filter. See Diagram C-3. If you have another pool heater, the three-way valve and tee should be installed before it.
3. You may want to install a check valve between the three-way valve and your filter. This will prevent the water that is in the panels from flowing backwards into the filter when your pump is turned off. If you install a check valve, make sure when you winterize your pool that all your piping is drained.
4. Run your feed and return PVC piping from your pool to your solar panels. Make sure piping is installed in such a way to allow proper drainage.
5. Make sure that your piping is connected the correct way and that all joints have been glued. Unblock the inlet and outlet of your pool.
6. Turn on your pool pump. Check for any leaks. You will see air bubbles coming from the pool inlet. This is normal, the air in the hoses is being purged.
7. Turn your solar heating system on by turning the three-way diverter valve. Once again you will see air bubbles coming from your pool. The system is now purging the air that is in the solar panel(s).

Note: A motorized valve and Automatic controls are optional items available from your local pool dealer

Operation and Maintenance

Turn on your solar heating system whenever the panel(s) are in sunlight. You will know the panel is working by touching it, it should feel cool to the touch. That means the heat from the sun is being transferred to the water inside the panel. Turn off your solar heating system at night and whenever it is raining. Failing to do so will cool your pool. It is recommended to close your solar heating system whenever you do a backwash or whenever you manually vacuum your swimming pool. It is also recommended to use a solar blanket or a Liquid Solar Blanket. This will help keep more of the heat generated by the solar panel in your pool.

Winterizing

System(s) on ground

At the end of the season, your solar panels **must be drained of all water.**

- After your pool has been closed, disconnect the hoses from the panel.
- Manipulate the panel until the water is completely out.
- Roll the panel up.
- Store the panel in a heated place until next season.

System(s) mounted on a roof or a rack

At the end of the season, your solar panels **must be drained of all water.**

- After your pool has been closed, turn your by-bass valve in such a way to allow the water from your panels to drain. Wait half an hour for panels to drain.
- Unscrew the Vacuum Relief Valve or the Threaded cap at the top of the solar system.
- Unscrew the Threaded cap at the bottom of the solar system and make sure all the water is drained out of the system. All your plumbing should be installed in such a way to allow full drainage of system. If you are not sure that all panels have been drained properly: disconnect each panel, raise them up and make sure that no water is present. Once completely drained, the panels can be left on the roof or rack. The SunQuest panels are designed to withstand the harshest winters.
- Apply Teflon to the Vacuum Relief Valve and Threaded Caps and re-screw them into the solar system. Do not over tighten.

Important : Unlike the pipes for your pool, blowing air in the panel will not drain it. The air will only empty a few tubes.

Internal Freeze damage is not covered by the warranty.

Troubleshooting

If you have any issues with your SunQuest, you can visit our website: www.sunquestsolarpanel.com and review our frequently asked questions section.

You can also contact our customer support department at 1-888-357-6527

Sunsolar Energy Technologies Inc
3262 F-X Tessier
Vaudreuil-Dorion, Qc, Can
J7V 5V5

SunQuest Solar Panel

Five Year Limited Warranty



Five year limited warranty from date of purchase with one full year. After the first year, the claimant shall pay the list price at the date of the claim less one-sixtieth (1/60) of the price for each full month remaining in the warranty period. Sunsolar Energy Technologies Inc. warrants to the original purchaser of the Solar Panel that the company will, at its option, repair or replace any solar panel that proves to be defective in either workmanship or material upon prepaid return of the solar panel by the owner to Sunsolar Energy Technologies Inc subject to the provisions of the limited warranty stated above, and the exclusion and limitations set forth below.

What is covered : The solar collector is warranted to be free of defects in material and workmanship when leaving the factory.

What is not covered : Hardware; including hoses, clamps and plastic fittings; any damage due to freezing caused by or related to improper drainage, winterization, or storage. Damage, defects, malfunctions, or other failures arising from use of the product which does not comply with the instructions provided by the manufacturer. Damage, defects, malfunctions, or other failures caused by or related to repairs performed by any servicer other than an authorized service representative of Sunsolar Energy Technologies Inc. Claims will not be accepted for a solar panel's damage in transit unless damage to shipping container is noted at time of delivery on the transport company's delivery bill.

Sunsolar Energy Technologies Inc shall in no way be liable or responsible under any circumstances or in any amount for any consequential or incidental damages or for any injury or damages to person or property using or used in connection with this product, or for loss of profits or other costs or expenses of any kind or character. There are no other warranties or representations, either express or implied, whether of merchantability, fitness for a particular purpose, or other, made by Sunsolar Energy Technologies Inc., other than those specifically set forth in this warranty. No person, firm, or corporation is authorized to make any representations, or incur any obligations in the name of or on behalf of Sunsolar Energy Technologies Inc. except as stated herein. This warranty is expressly understood to be the exclusive remedy available to the purchaser, and this warranty contains the full and complete agreement between Sunsolar Energy Technologies Inc and the purchaser. This warranty sets forth the only obligations of Sunsolar Energy Technologies Inc. with regard to this product, and there are no warranties which extend beyond the description on the face hereof.

To file a claim : Call 1-888-357-6527 to initiate a claim. Please allow 2-4 weeks for warranty claims to be settled.

The representation set forth herein are the only representations made by Sunsolar Energy Technologies Inc with respect to the product, and this warranty does not constitute either a performance or satisfaction guarantee. It is the responsibility of the product owner to regularly test and check the product for proper function and safety.

Sunsolar Energy Technologies Inc., 3262 F-X Tessier, Vaudreuil-Dorion, Qc, J7V 5V5



WARRANTY REGISTRATION

Please enter your Warranty Registration on line at: www.sunquestsolarpanel.com

or

Please complete and mail to the address below:

Name : _____ Phone # : () _____

Address : _____

City : _____ Prov/State : _____ Postal/Zip Code : _____

Dealer name : _____ Date of purchase : _____

Retail Price : _____ Pool size : _____ Signature : _____

Sunsolar Energy Technologies Inc
3262 F-X Tessier
Vaudreuil-Dorion, Qc, J7V 5V5